

Schranksystem Monaco.

V.i.P.
by Wiemann

Monaco 1000
Drehtürenschränke

Monaco 2000
Falttürenschränke

Monaco 3000
Schwebetürenschränke

Monaco 4000
Betten + Beimöbel

Monaco 5000
Offenes Schranksystem

MONACO 3000 - Komplettschränke

Schrankvorschläge

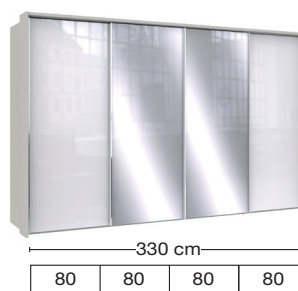
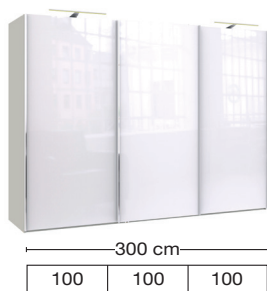
 Mitteltüren mit
Synchron-Öffnung

 Für diese **Komplettschränke** sind **optional Passepartout-Rahmen oder Kranzleisten** möglich, wahlweise mit integrierter Beleuchtung (s. Schrankzubehör).

Kombinierte Schränke (individuell zusammenstellbar) aus MONACO 1000 + 2000 + 3000

1. Beispiel:

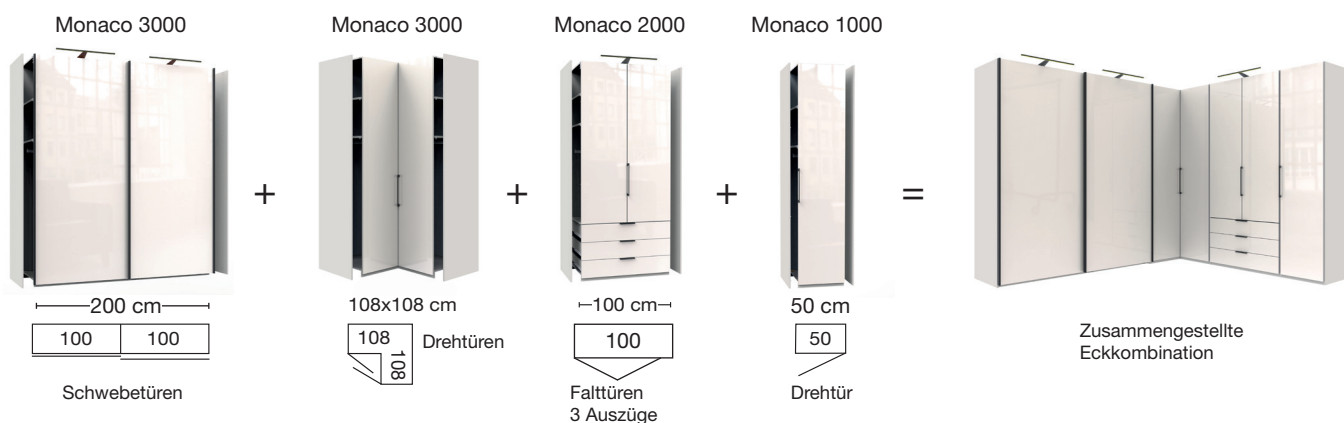

2. Beispiel:

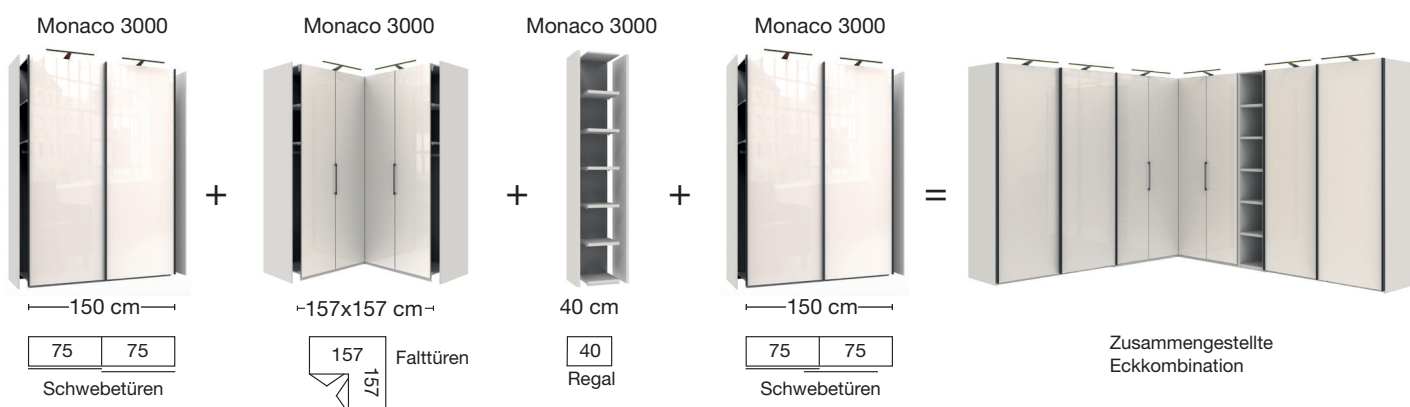



Die einzelnen Schränke verfügen je Korpus über zwei Außenseiten und werden aneinandergestellt.

 Für diese Planungsschränke sind **optional Aufbauleuchten** wählbar.

LIEFERBARE KORPUS- UND FRONTAUSFÜHRUNGEN

Bitte geben Sie bei jeder Bestellung die exakte Farbkombination aus Front- und Korpusfarbe an!

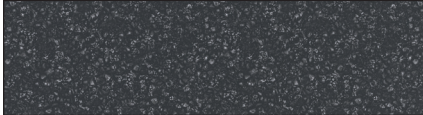
Farbausführungen:

 Griffleisten in chrom 	 Griffleisten in silber 	 Griffleisten in Schiefer-NB 
 Modell-Nr. 334 Bianco-Eiche- Nachbildung	 Modell-Nr. 345 Bianco-Eiche- Nachbildung	 Modell-Nr. 349 Bianco-Eiche- Nachbildung
Modell-Nr. 342 Weiß	Modell-Nr. 346 Weiß	Modell-Nr. 357 Weiß
Modell-Nr. 343 Kieselgrau- Dekor	Modell-Nr. 347 Kieselgrau- Dekor	Modell-Nr. 358 Kieselgrau- Dekor
Modell-Nr. 344 Champagner-Dekor	Modell-Nr. 348 Champagner-Dekor	Modell-Nr. 359 Champagner-Dekor
Modell-Nr. 395 Graphit-Dekor	Modell-Nr. 480 Graphit-Dekor	Modell-Nr. 490 Graphit-Dekor

Monaco 3000. Schwebetürenschränke.

V.i.P.
by Wiemann

Dekorfronten

**Bianco-Eiche-
Nachbildung**

Weiß

**Kieselgrau-
Dekor**

**Champagner-
Dekor**

Graphit-Dekor

Glasfronten

Glas weiß

**Glas
Kieselgrau**

**Glas
Champagner**

Querriegel

**Bianco-Eiche-
Nachbildung**

Graphit-Dekor

**Kieselgrau-
Dekor**

**Champagner-
Dekor**

Spiegel

Kristallspiegel

Innenfarbton

**Streifendekor
silber-grau**

furnplan



Emissionsgeprüft
Schadstoffgeprüft
Regelmäßige
Produkt-
überwachung

www.tuv.com
ID 1111253053

Monaco 3000. Schwebetürenschränke.

V.i.P.
by Wiemann

Korpusbreiten

Schwebetürenschränke

Breite	Seite	Sockel	Seite	Sockel	Seite	Sockel	Seite	Sockel	Seite	Breite effektiv
150	1,5	72,2	1,5	72,2	1,5					148,9 cm
200	1,5	96,4	1,5	96,4	1,5					197,3 cm
225	1,5	72,2	1,5	72,2	1,5	72,2	1,5			222,6 cm
250	1,5	80,1	1,5	80,1	1,5	80,1	1,5			246,3 cm
280	1,5	96,4	1,5	80,1	1,5	96,4	1,5			278,9 cm
300	1,5	96,4	1,5	96,4	1,5	96,4	1,5			295,2 cm
300	1,5	72,2	1,5	72,2	1,5	72,2	1,5	72,2	1,5	296,3 cm
330	1,5	80,1	1,5	80,1	1,5	80,1	1,5	80,1	1,5	327,9 cm
400	1,5	96,4	1,5	96,4	1,5	96,4	1,5	96,4	1,5	393,1 cm

furnplan



Emissionsgeprüft
Schadstoffgeprüft
Regelmäßige
Produkt-
überwachung

www.tuv.com
ID 1111253053

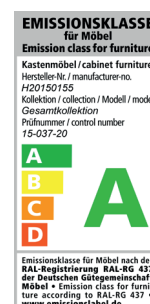

Farb- und Modellabweichungen bzw. die Korrektur von irrtümlichen Angaben behalten wir uns vor. Alle Maße sind Ca.-Maße in cm.

Monaco 3000.

V.i.P.
by Wiemann

Schwebetürenschränke

Innenausstattung:

2 Einlegeböden, 1 Kleiderstange

Front schlicht

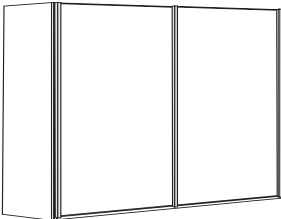
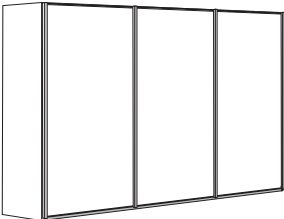
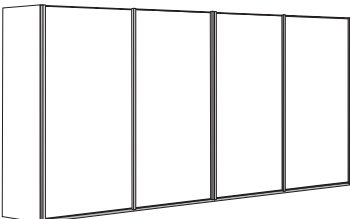
Beschreibung	Maße in cm		Höhe 217 cm		Höhe 236 cm	
	B	T	Art.-Nr.	EURO	Art.-Nr.	EURO
Front im Korpus-Farbtön						
	2-türig	150	67	200		209
	2-türig	200	67	201		210
	3-türig	225	67	202		211
	3-türig	250	67	203		212
	3-türig	280	67	204		213
	3-türig	300	67	205		214
	- mit Synchronöffnung					
	4-türig	300	67	206		215
	4-türig	330	67	207		216
	4-türig	400	67	208		217

Sockel-Aufteilung

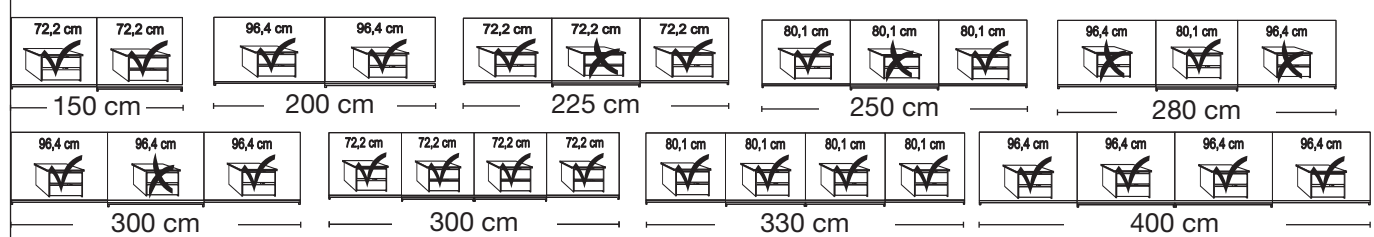

Monaco 3000.



V.i.P.
by Wiemann

Schwebetürenschränke





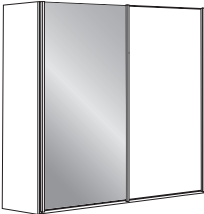
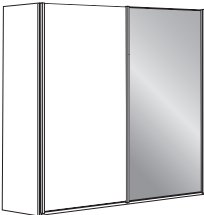
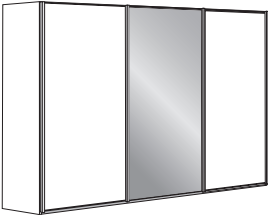
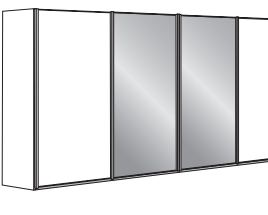
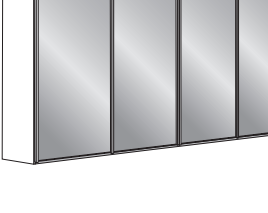
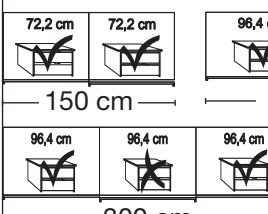























Innenausstattung:

2 Einlegeböden, 1 Kleiderstange

Front schlicht

Beschreibung	Maße in cm		Höhe 217 cm		Höhe 236 cm	
	B	T	Art.-Nr.	EURO	Art.-Nr.	EURO
Front im Korpus-Farbtön und Kristallspiegeltüren						
	2-türig	1 Spiegeltür links	150	67	218	238
	2-türig	1 Spiegeltür rechts	150	67	219	239
	2-türig	2 Spiegeltüren	150	67	220	240
	2-türig	1 Spiegeltür links	200	67	221	241
	2-türig	1 Spiegeltür rechts	200	67	222	242
	2-türig	2 Spiegeltüren	200	67	223	243
	3-türig	1 Spiegeltür mittig	225	67	224	244
	3-türig	3 Spiegeltüren	225	67	225	245
	3-türig	1 Spiegeltür mittig	250	67	226	246
	3-türig	3 Spiegeltüren	250	67	227	247
	3-türig	1 Spiegeltür mittig	280	67	228	248
	3-türig	3 Spiegeltüren	280	67	229	249
	3-türig	1 Spiegeltür mittig	300	67	230	250
	3-türig	3 Spiegeltüren	300	67	231	251
	- mit Synchronöffnung					
	4-türig	2 Spiegeltüren mittig	300	67	232	252
	4-türig	4 Spiegeltüren	300	67	233	253
	4-türig	2 Spiegeltüren mittig	330	67	234	254
	4-türig	4 Spiegeltüren	330	67	235	255
	4-türig	2 Spiegeltüren mittig	400	67	236	256
	4-türig	4 Spiegeltüren	400	67	237	257

Sockel-Aufteilung

														
150 cm		200 cm		225 cm			250 cm			280 cm				
														
300 cm			300 cm				330 cm				400 cm			

Monaco 3000.

V.i.P.
by Wiemann

Schwebetürenschränke

Innenausstattung:

2 Einlegeböden, 1 Kleiderstange

Front schlicht

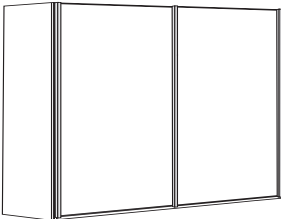
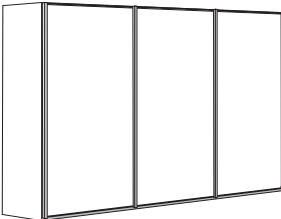
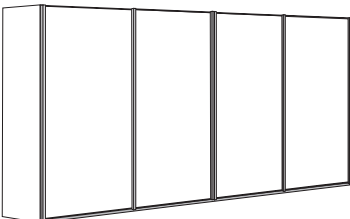
Beschreibung	Maße in cm		Höhe 217 cm		Höhe 236 cm	
	B	T	Art.-Nr.	EURO	Art.-Nr.	EURO
Front in weiß						
	2-türig	150	67	500		509
	2-türig	200	67	501		510
	3-türig	225	67	502		511
	3-türig	250	67	503		512
	3-türig	280	67	504		513
	3-türig	300	67	505		514
	- mit Synchronöffnung					
	4-türig	300	67	506		515
	4-türig	330	67	507		516
	4-türig	400	67	508		517

Sockel-Aufteilung

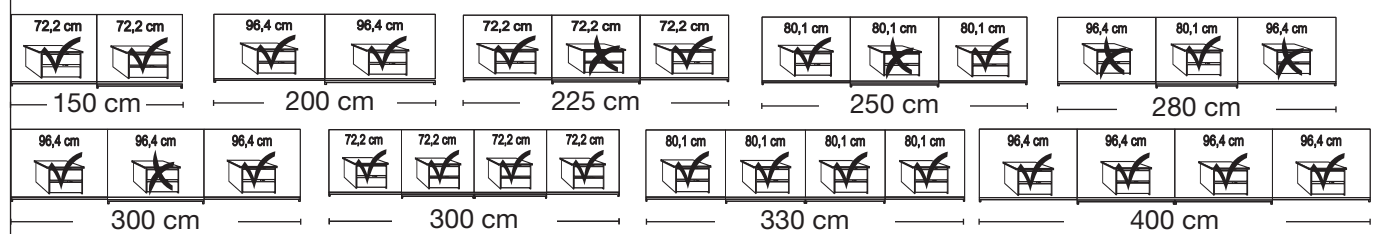

Monaco 3000.



V.i.P.
 by Wiemann

Schwebetürenschränke





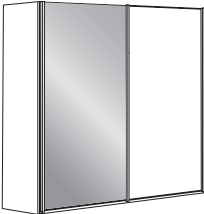
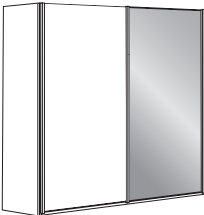
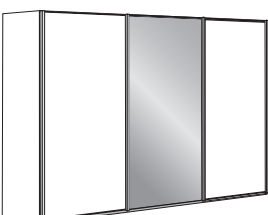
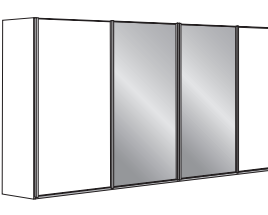

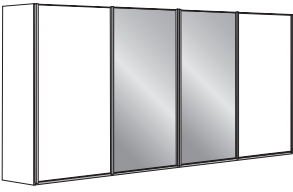
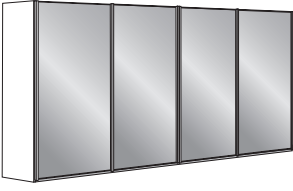





















Innenausstattung:

2 Einlegeböden, 1 Kleiderstange

Front schlicht

Beschreibung	Maße in cm		Höhe 217 cm		Höhe 236 cm	
	B	T	Art.-Nr.	EURO	Art.-Nr.	EURO
Front in weiß und Kristallspiegeltüren						
	2-türig	1 Spiegeltür links	150	67	518	538
	2-türig	1 Spiegeltür rechts	150	67	519	539
	2-türig	2 Spiegeltüren	150	67	520	540
	2-türig	1 Spiegeltür links	200	67	521	541
	2-türig	1 Spiegeltür rechts	200	67	522	542
	2-türig	2 Spiegeltüren	200	67	523	543
	3-türig	1 Spiegeltür mittig	225	67	524	544
	3-türig	3 Spiegeltüren	225	67	525	545
	3-türig	1 Spiegeltür mittig	250	67	526	546
	3-türig	3 Spiegeltüren	250	67	527	547
	3-türig	1 Spiegeltür mittig	280	67	528	548
	3-türig	3 Spiegeltüren	280	67	529	549
	3-türig	1 Spiegeltür mittig	300	67	530	550
	3-türig	3 Spiegeltüren	300	67	531	551
	- mit Synchronöffnung					
	4-türig	2 Spiegeltüren mittig	300	67	532	552
	4-türig	4 Spiegeltüren	300	67	533	553
	4-türig	2 Spiegeltüren mittig	330	67	534	554
	4-türig	4 Spiegeltüren	330	67	535	555
	4-türig	2 Spiegeltüren mittig	400	67	536	556
	4-türig	4 Spiegeltüren	400	67	537	557

Sockel-Aufteilung

															
150 cm		200 cm		225 cm			250 cm			280 cm					
															
300 cm			300 cm				330 cm				400 cm				

Monaco 3000.

V.i.P.
by Wiemann

Schwebetürenschränke

Innenausstattung:

2 Einlegeböden, 1 Kleiderstange

Front schlicht

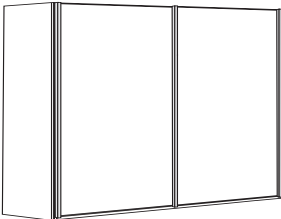
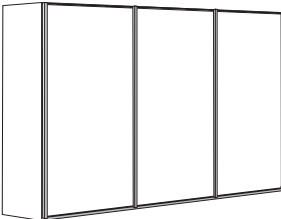
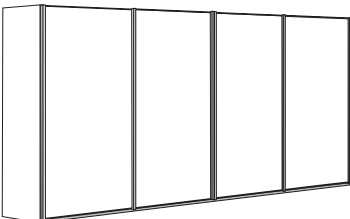
Beschreibung	Maße in cm		Höhe 217 cm		Höhe 236 cm	
	B	T	Art.-Nr.	EURO	Art.-Nr.	EURO
Front in Kieselgrau-Dekor						
	2-türig	150	67	558		572
	2-türig	200	67	559		573
	3-türig	225	67	560		574
	3-türig	250	67	561		575
	3-türig	280	67	562		576
	3-türig	300	67	566		577
	- mit Synchronöffnung					
	4-türig	300	67	567		578
	4-türig	330	67	568		579
	4-türig	400	67	571		580

Sockel-Aufteilung

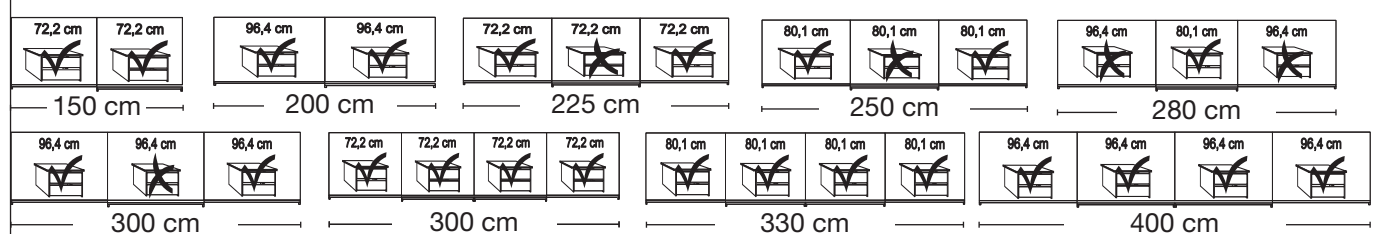

Monaco 3000.





V.i.P.
 by Wiemann

Schwebetürenschränke



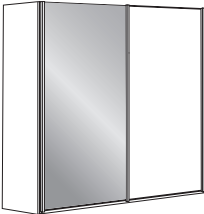
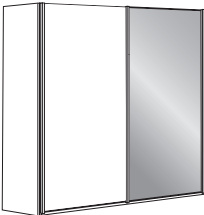
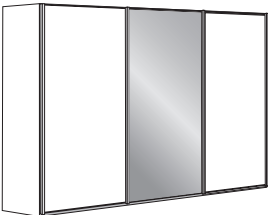
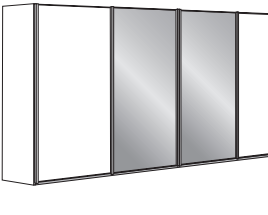

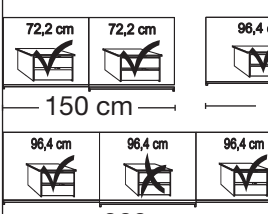























Innenausstattung:

2 Einlegeböden, 1 Kleiderstange

Front schlicht

Beschreibung	Maße in cm		Höhe 217 cm		Höhe 236 cm	
	B	T	Art.-Nr.	EURO	Art.-Nr.	EURO
Front in Kieselgrau-Dekor und Kristallspiegeltüren						
	2-türig	1 Spiegeltür links	150	67	581	601
	2-türig	1 Spiegeltür rechts	150	67	582	602
	2-türig	2 Spiegeltüren	150	67	583	603
	2-türig	1 Spiegeltür links	200	67	584	604
	2-türig	1 Spiegeltür rechts	200	67	585	605
	2-türig	2 Spiegeltüren	200	67	586	606
	3-türig	1 Spiegeltür mittig	225	67	587	607
	3-türig	3 Spiegeltüren	225	67	588	608
	3-türig	1 Spiegeltür mittig	250	67	589	609
	3-türig	3 Spiegeltüren	250	67	590	610
	3-türig	1 Spiegeltür mittig	280	67	591	611
	3-türig	3 Spiegeltüren	280	67	592	612
	3-türig	1 Spiegeltür mittig	300	67	593	613
	3-türig	3 Spiegeltüren	300	67	594	614
	- mit Synchronöffnung					
	4-türig	2 Spiegeltüren mittig	300	67	595	615
	4-türig	4 Spiegeltüren	300	67	596	616
	4-türig	2 Spiegeltüren mittig	330	67	597	617
	4-türig	4 Spiegeltüren	330	67	598	618
	4-türig	2 Spiegeltüren mittig	400	67	599	619
	4-türig	4 Spiegeltüren	400	67	600	620

Sockel-Aufteilung

														
150 cm		200 cm		225 cm			250 cm			280 cm				
														
300 cm			300 cm				330 cm				400 cm			

Monaco 3000.

V.i.P.
by Wiemann

Schwebetürenschränke

Innenausstattung:

2 Einlegeböden, 1 Kleiderstange

Front schlicht

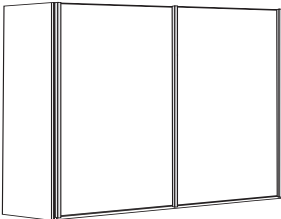
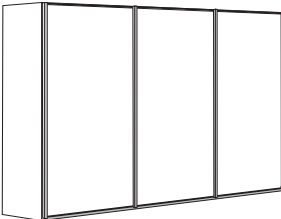
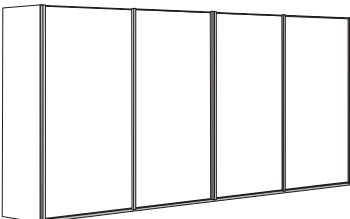
Beschreibung	Maße in cm		Höhe 217 cm		Höhe 236 cm	
	B	T	Art.-Nr.	EURO	Art.-Nr.	EURO
Front in Champagner-Dekor						
	2-türig	150	67	621		630
	2-türig	200	67	622		631
	3-türig	225	67	623		632
	3-türig	250	67	624		633
	3-türig	280	67	625		634
	3-türig	300	67	626		635
	- mit Synchronöffnung					
	4-türig	300	67	627		636
	4-türig	330	67	628		637
	4-türig	400	67	629		638

Sockel-Aufteilung

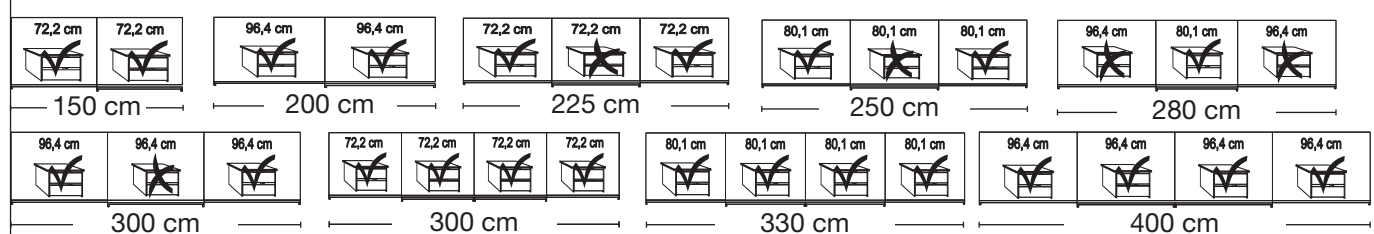

Monaco 3000.

V.i.P.
 by Wiemann

Schwebetürenschränke







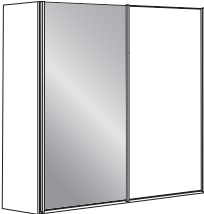
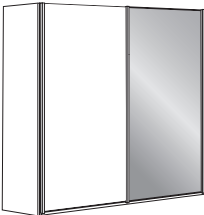
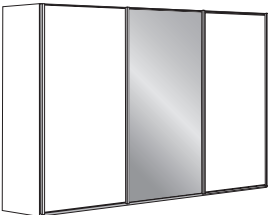
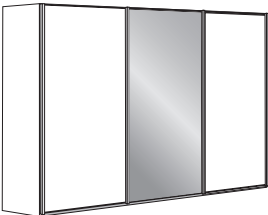
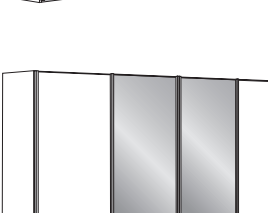
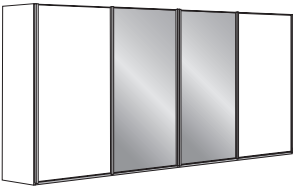
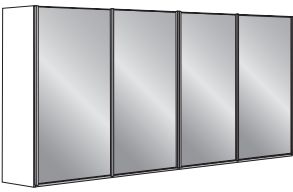





















Innenausstattung:

2 Einlegeböden, 1 Kleiderstange

Front schlicht

Beschreibung	Maße in cm		Höhe 217 cm		Höhe 236 cm	
	B	T	Art.-Nr.	EURO	Art.-Nr.	EURO
Front in Champagner-Dekor und Kristallspiegeltüren						
	2-türig	1 Spiegeltür links	150	67	639	659
	2-türig	1 Spiegeltür rechts	150	67	640	660
	2-türig	2 Spiegeltüren	150	67	641	661
	2-türig	1 Spiegeltür links	200	67	642	662
	2-türig	1 Spiegeltür rechts	200	67	643	663
	2-türig	2 Spiegeltüren	200	67	644	664
	3-türig	1 Spiegeltür mittig	225	67	645	665
	3-türig	3 Spiegeltüren	225	67	646	666
	3-türig	1 Spiegeltür mittig	250	67	647	667
	3-türig	3 Spiegeltüren	250	67	648	668
	3-türig	1 Spiegeltür mittig	280	67	649	669
	3-türig	3 Spiegeltüren	280	67	650	670
	3-türig	1 Spiegeltür mittig	300	67	651	671
	3-türig	3 Spiegeltüren	300	67	652	672
	- mit Synchronöffnung					
	4-türig	2 Spiegeltüren mittig	300	67	653	673
	4-türig	4 Spiegeltüren	300	67	654	674
	4-türig	2 Spiegeltüren mittig	330	67	655	675
	4-türig	4 Spiegeltüren	330	67	656	676
	4-türig	2 Spiegeltüren mittig	400	67	657	677
	4-türig	4 Spiegeltüren	400	67	658	678

Sockel-Aufteilung

														
150 cm		200 cm		225 cm			250 cm			280 cm				
														
300 cm			300 cm				330 cm				400 cm			

Monaco 3000.

V.i.P.
by Wiemann

Schwebetürenschränke





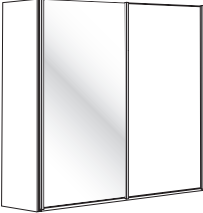
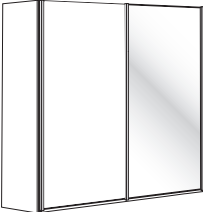
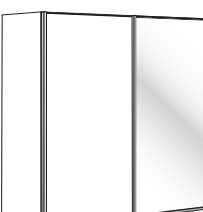
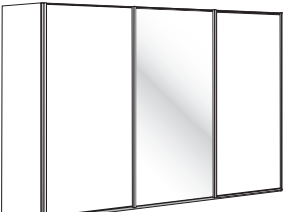
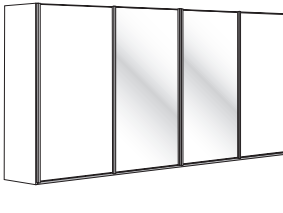
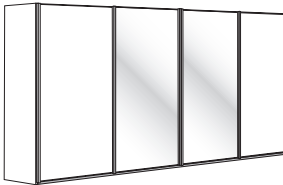
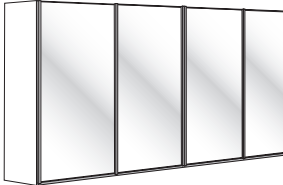

Innenausstattung:

2 Einlegeböden, 1 Kleiderstange

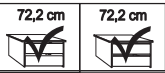
Front schlicht

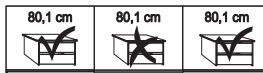
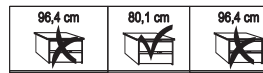
Beschreibung	Maße in cm		Höhe 217 cm		Höhe 236 cm	
	B	T	Art.-Nr.	EURO	Art.-Nr.	EURO
Glastüren in weiß in Kombination mit Türen im Korpus-Farbton						
	2-türig	1 Glastür links	150	67	258	278
	2-türig	1 Glastür rechts	150	67	259	279
	2-türig	2 Glastüren	150	67	260	280
	2-türig	1 Glastür links	200	67	261	281
	2-türig	1 Glastür rechts	200	67	262	282
	2-türig	2 Glastüren	200	67	263	283
	3-türig	1 Glastür mittig	225	67	264	284
	3-türig	3 Glastüren	225	67	265	285
	3-türig	1 Glastür mittig	250	67	266	286
	3-türig	3 Glastüren	250	67	267	287
	3-türig	1 Glastür mittig	280	67	268	288
	3-türig	3 Glastüren	280	67	269	289
	3-türig	1 Glastür mittig	300	67	270	290
	3-türig	3 Glastüren	300	67	271	291
	- mit Synchronöffnung					
	4-türig	2 Glastüren mittig	300	67	272	292
	4-türig	4 Glastüren	300	67	273	293
	4-türig	2 Glastüren mittig	330	67	274	294
	4-türig	4 Glastüren	330	67	275	295
	4-türig	2 Glastüren mittig	400	67	276	296
4-türig	4 Glastüren	400	67	277	297	

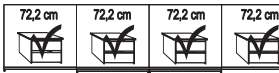
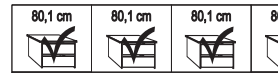
Sockel-Aufteilung

				
150 cm	200 cm	225 cm	250 cm	280 cm
				
300 cm	300 cm	330 cm	400 cm	

Monaco 3000.

V.i.P.





by Wiemann

Schwebetürenschränke



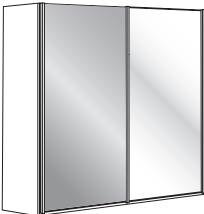
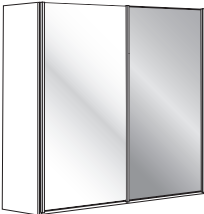
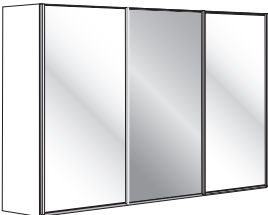
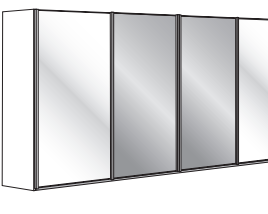

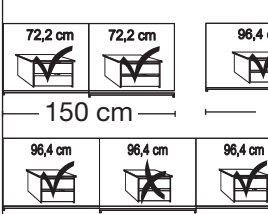























Innenausstattung:

2 Einlegeböden, 1 Kleiderstange

Front schlicht

Beschreibung	Maße in cm		Höhe 217 cm		Höhe 236 cm	
	B	T	Art.-Nr.	EURO	Art.-Nr.	EURO
Glastüren in weiß und Kristallspiegeltüren						
	2-türig	1 Spiegeltür links	150	67	298	318
	2-türig	1 Spiegeltür rechts	150	67	299	319
	2-türig	2 Spiegeltüren	150	67	300	320
	2-türig	1 Spiegeltür links	200	67	301	321
	2-türig	1 Spiegeltür rechts	200	67	302	322
	2-türig	2 Spiegeltüren	200	67	303	323
	3-türig	1 Spiegeltür mittig	225	67	304	324
	3-türig	3 Spiegeltüren	225	67	305	325
	3-türig	1 Spiegeltür mittig	250	67	306	326
	3-türig	3 Spiegeltüren	250	67	307	327
	3-türig	1 Spiegeltür mittig	280	67	308	328
	3-türig	3 Spiegeltüren	280	67	309	329
	3-türig	1 Spiegeltür mittig	300	67	310	330
	3-türig	3 Spiegeltüren	300	67	311	331
	- mit Synchronöffnung					
	4-türig	2 Spiegeltüren mittig	300	67	312	332
	4-türig	4 Spiegeltüren	300	67	313	333
	4-türig	2 Spiegeltüren mittig	330	67	314	334
	4-türig	4 Spiegeltüren	330	67	315	335
	4-türig	2 Spiegeltüren mittig	400	67	316	336
	4-türig	4 Spiegeltüren	400	67	317	337

Sockel-Aufteilung

														
150 cm		200 cm		225 cm			250 cm			280 cm				
														
300 cm			300 cm				330 cm				400 cm			

Monaco 3000.

V.i.P.
by Wiemann

Schwebetürenschränke

Innenausstattung:

2 Einlegeböden, 1 Kleiderstange

Front schlicht

Beschreibung	Maße in cm		Höhe 217 cm		Höhe 236 cm	
	B	T	Art.-Nr.	EURO	Art.-Nr.	EURO
Glastüren in Kieselgrau in Kombination mit Türen im Korpus-Farbtönen						
	2-türig	1 Glastür links	150	67	338	358
	2-türig	1 Glastür rechts	150	67	339	359
	2-türig	2 Glastüren	150	67	340	360
	2-türig	1 Glastür links	200	67	341	361
	2-türig	1 Glastür rechts	200	67	342	362
	2-türig	2 Glastüren	200	67	343	563
	3-türig	1 Glastür mittig	225	67	344	564
	3-türig	3 Glastüren	225	67	345	565
	3-türig	1 Glastür mittig	250	67	346	366
	3-türig	3 Glastüren	250	67	347	367
	3-türig	1 Glastür mittig	280	67	348	368
	3-türig	3 Glastüren	280	67	349	569
	3-türig	1 Glastür mittig	300	67	350	570
	3-türig	3 Glastüren	300	67	351	371
	- mit Synchronöffnung					
	4-türig	2 Glastüren mittig	300	67	352	372
	4-türig	4 Glastüren	300	67	353	373
	4-türig	2 Glastüren mittig	330	67	354	374
	4-türig	4 Glastüren	330	67	355	375
	4-türig	2 Glastüren mittig	400	67	356	376
	4-türig	4 Glastüren	400	67	357	377

Sockel-Aufteilung

150 cm	200 cm	225 cm	250 cm	280 cm
300 cm	300 cm	330 cm	400 cm	400 cm

Monaco 3000.



V.i.P.
by Wiemann

Schwebetürenschränke





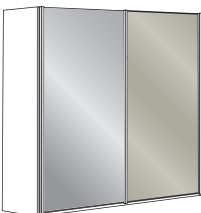
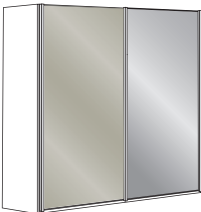
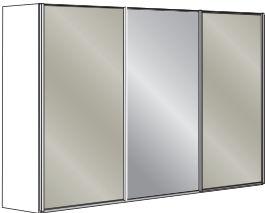
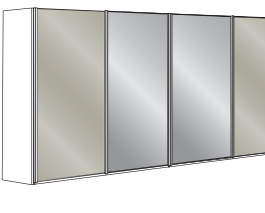
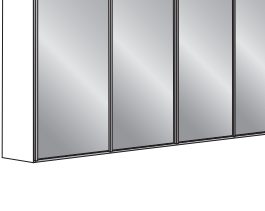
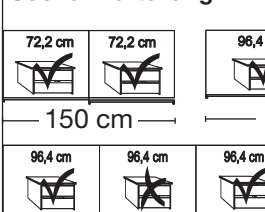























Innenausstattung:

2 Einlegeböden, 1 Kleiderstange

Front schlicht

Beschreibung	Maße in cm		Höhe 217 cm		Höhe 236 cm	
	B	T	Art.-Nr.	EURO	Art.-Nr.	EURO
Glastüren in Kieselgrau und Kristallspiegeltüren						
	2-türig	1 Spiegeltür links	150	67	378	398
	2-türig	1 Spiegeltür rechts	150	67	379	399
	2-türig	2 Spiegeltüren	150	67	380	400
	2-türig	1 Spiegeltür links	200	67	381	401
	2-türig	1 Spiegeltür rechts	200	67	382	402
	2-türig	2 Spiegeltüren	200	67	383	403
	3-türig	1 Spiegeltür mittig	225	67	384	404
	3-türig	3 Spiegeltüren	225	67	385	405
	3-türig	1 Spiegeltür mittig	250	67	386	406
	3-türig	3 Spiegeltüren	250	67	387	407
	3-türig	1 Spiegeltür mittig	280	67	388	408
	3-türig	3 Spiegeltüren	280	67	389	409
	3-türig	1 Spiegeltür mittig	300	67	390	410
	3-türig	3 Spiegeltüren	300	67	391	411
	- mit Synchronöffnung					
	4-türig	2 Spiegeltüren mittig	300	67	392	412
	4-türig	4 Spiegeltüren	300	67	393	413
	4-türig	2 Spiegeltüren mittig	330	67	394	414
	4-türig	4 Spiegeltüren	330	67	395	415
	4-türig	2 Spiegeltüren mittig	400	67	396	416
	4-türig	4 Spiegeltüren	400	67	397	417

Sockel-Aufteilung

														
150 cm		200 cm		225 cm			250 cm			280 cm				
														
300 cm			300 cm				330 cm				400 cm			

Monaco 3000.





V.i.P.
by Wiemann

Schwebetürenschränke

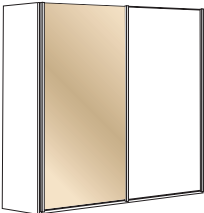
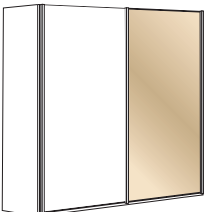
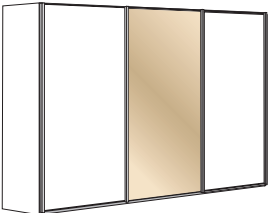
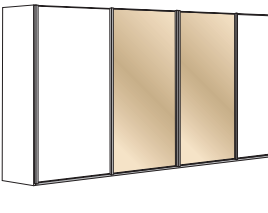

Innenausstattung:

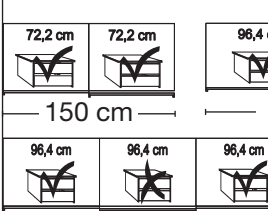
2 Einlegeböden, 1 Kleiderstange

Front schlicht

Beschreibung	Maße in cm		Höhe 217 cm		Höhe 236 cm	
	B	T	Art.-Nr.	EURO	Art.-Nr.	EURO
Glastüren in Champagner in Kombination mit Türen im Korpus-Farbtönen						
	2-türig	1 Glastür links	150	67	418	438
	2-türig	1 Glastür rechts	150	67	419	439
	2-türig	2 Glastüren	150	67	420	440
	2-türig	1 Glastür links	200	67	421	441
	2-türig	1 Glastür rechts	200	67	422	442
	2-türig	2 Glastüren	200	67	423	443
	3-türig	1 Glastür mittig	225	67	424	444
	3-türig	3 Glastüren	225	67	425	445
	3-türig	1 Glastür mittig	250	67	426	446
	3-türig	3 Glastüren	250	67	427	447
	3-türig	1 Glastür mittig	280	67	428	448
	3-türig	3 Glastüren	280	67	429	449
	3-türig	1 Glastür mittig	300	67	430	450
	3-türig	3 Glastüren	300	67	431	451
	- mit Synchronöffnung					
	4-türig	2 Glastüren mittig	300	67	432	452
	4-türig	4 Glastüren	300	67	433	453
	4-türig	2 Glastüren mittig	330	67	434	454
	4-türig	4 Glastüren	330	67	435	455
	4-türig	2 Glastüren mittig	400	67	436	456
	4-türig	4 Glastüren	400	67	437	457

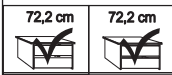
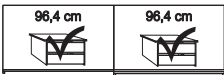
Sockel-Aufteilung

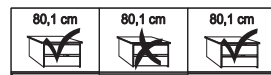
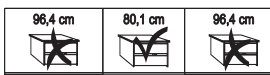
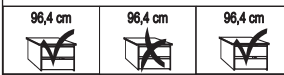
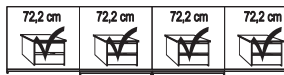
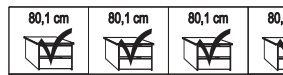
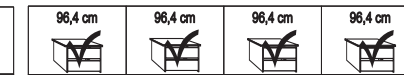
				
150 cm	200 cm	225 cm	250 cm	280 cm
				
300 cm	300 cm	330 cm	400 cm	

Monaco 3000.





V.i.P.
 by Wiemann

Schwebetürenschränke

Innenausstattung:

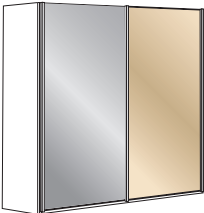
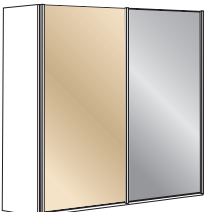
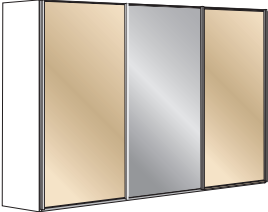
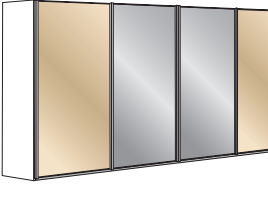
2 Einlegeböden, 1 Kleiderstange

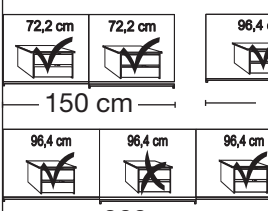
Front schlicht

Beschreibung	Maße in cm		Höhe 217 cm		Höhe 236 cm	
	B	T	Art.-Nr.	EURO	Art.-Nr.	EURO
Glastüren in Champagner und Kristallspiegeltüren						
	2-türig	1 Spiegeltür links	150	67	458	478
	2-türig	1 Spiegeltür rechts	150	67	459	479
	2-türig	2 Spiegeltüren	150	67	460	480
	2-türig	1 Spiegeltür links	200	67	461	481
	2-türig	1 Spiegeltür rechts	200	67	462	482
	2-türig	2 Spiegeltüren	200	67	463	483
	3-türig	1 Spiegeltür mittig	225	67	464	484
	3-türig	3 Spiegeltüren	225	67	465	485
	3-türig	1 Spiegeltür mittig	250	67	466	486
	3-türig	3 Spiegeltüren	250	67	467	487
	3-türig	1 Spiegeltür mittig	280	67	468	488
	3-türig	3 Spiegeltüren	280	67	469	489
	3-türig	1 Spiegeltür mittig	300	67	470	490
	3-türig	3 Spiegeltüren	300	67	471	491
	- mit Synchronöffnung					
	4-türig	2 Spiegeltüren mittig	300	67	472	492
	4-türig	4 Spiegeltüren	300	67	473	493
	4-türig	2 Spiegeltüren mittig	330	67	474	494
	4-türig	4 Spiegeltüren	330	67	475	495
	4-türig	2 Spiegeltüren mittig	400	67	476	496
	4-türig	4 Spiegeltüren	400	67	477	497

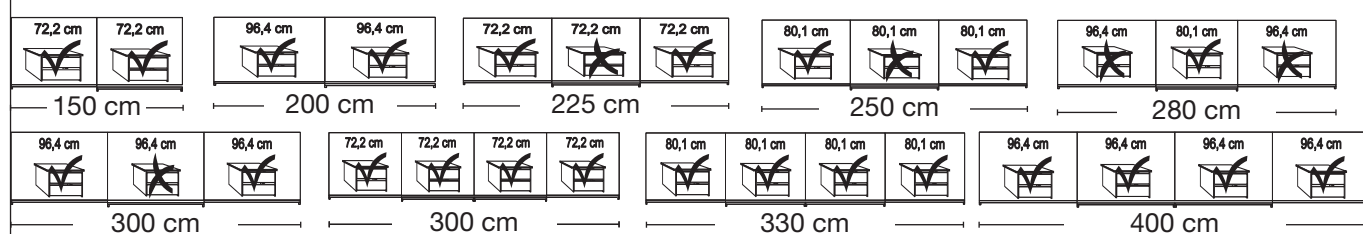
Sockel-Aufteilung



Monaco 3000.

V.i.P.
by Wiemann

Eckschränke ohne Kranzleiste

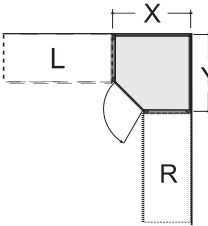
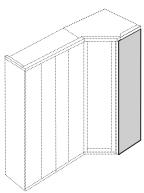

In Kombination mit Schwebetüren-
schränken keine Kranzleisten oder
Passepartout-Rahmen möglich!

Beschreibung	Maße in cm		Höhe 216 cm		Höhe 236 cm		
	B	T	Art.-Nr.	EURO	Art.-Nr.	EURO	
 	Eckschrank vollausgebaut						
	Tür LINKS angeschlagen:						
	1-türig - Front im Korpus-Farbton	93	93	774		779	
	1-türig - Front in weiß	93	93	F81		F87	
	1-türig - Front in Kieselgrau-Dekor	93	93	F82		F88	
	1-türig - Front in Champagner-Dekor	93	93	F83		F89	
	1-türig - Front Glas weiß	93	93	775		780	
	1-türig - Front Glas Kieselgrau	93	93	776		781	
	1-türig - Front Glas Champagner	93	93	777		782	
	1-türig - Front Kristallspiegel	93	93	778		783	
	Tür RECHTS angeschlagen:						
	1-türig - Front im Korpus-Farbton	93	93	784		789	
	1-türig - Front in weiß	93	93	F84		F90	
	1-türig - Front in Kieselgrau-Dekor	93	93	F85		F91	
1-türig - Front in Champagner-Dekor	93	93	F86		F92		
1-türig - Front Glas weiß	93	93	785		790		
1-türig - Front Glas Kieselgrau	93	93	786		791		
1-türig - Front Glas Champagner	93	93	787		792		
1-türig - Front Kristallspiegel	93	93	788		793		
 Stellmaße siehe Seite 19 / 20							
Innenausstattung: 2 Einlegeböden, 1 Kleiderstange je Fach Alle Drehtüren inkl. gedämpfter Scharniere							
 Abschlussseite für ausgebauten Eckschrank, beidseitig (links und rechts) verwendbar	56	1,5	090		091		
Wird benötigt, wenn mit ausgebautem Eckschrank abgeschlossen wird. Wird ein Eckschrank separat aufgestellt, werden 2 Außenseiten benötigt.							



Monaco 3000.

V.i.P.
by Wiemann

Eckschränke ohne Kranzleiste

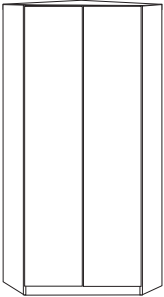

In Kombination mit Schwebetüren-
schränken keine Kranzleisten oder
Passepartout-Rahmen möglich!

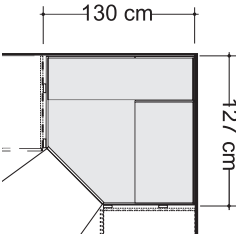
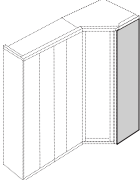
Beschreibung	Maße in cm		Höhe 216 cm		Höhe 236 cm	
	B	T	Art.-Nr.	EURO	Art.-Nr.	EURO
 <p>Begehbarer Eckschrank mit Drehtüren</p> <p>2-türig - Front im Korpus-Farbtön</p> <p>2-türig - Front in weiß</p> <p>2-türig - Front in Kieselgrau-Dekor</p> <p>2-türig - Front in Champagner-Dekor</p> <p>2-türig - Front Glas weiß</p> <p>2-türig - Front Glas Kieselgrau</p> <p>2-türig - Front Glas Champagner</p> <p>2-türig - Front Kristallspiegel</p>						
	130	127	799		809	
	130	127	F93		F96	
	130	127	F94		F97	
	130	127	F95		F98	
	130	127	800		810	
	130	127	801		811	
	130	127	802		812	
130	127	803		813		
 <p>Stellmaße siehe Seite 19 / 20</p> 						
<p>Innenausstattung: B 72,2 cm: 2 E-Böden, 1 Kleiderstange, B 125 cm: 5 E-Böden, Beleuchtung mit Bewegungsmelder</p> <p>Alle Drehtüren inkl. gedämpfter Scharniere</p> <p><small>Dieses Produkt enthält eine Licht- quelle der Energieeffizienzklasse G</small></p>						
 <p>Abschlussseite für begehbaren Eckschrank, beidseitig - links und rechts - verwendbar</p> <p>Wird benötigt, wenn mit einem Eck- schrank abgeschlossen wird. Wird ein Eckschrank separat aufgestellt, werden 2 Außenseiten benötigt.</p>	56	1,5	090		091	



Monaco 3000.

V.i.P.
by Wiemann

Eckschränke ohne Kranzleiste

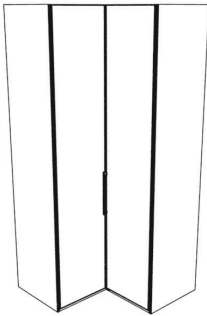
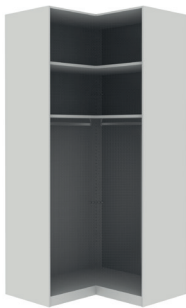
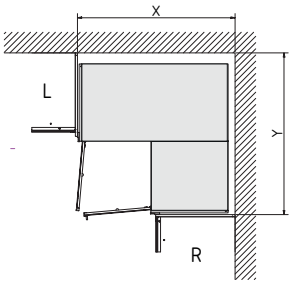

In Kombination mit Schwebetüren-
schränken keine Kranzleisten oder
Passepartout-Rahmen möglich!

Beschreibung	Maße in cm		Höhe 216 cm		Höhe 236 cm	
	B	T	Art.-Nr.	EURO	Art.-Nr.	EURO
 <p>Eckschrank über 90 Grad mit Drehtüren</p> <ul style="list-style-type: none"> - Front im Korpus-Farbtone - Front in weiß - Front in Kieselgrau-Dekor - Front in Champagner-Dekor  <ul style="list-style-type: none"> - Front Glas weiß - Front Glas Kieselgrau - Front Glas Champagner - Front Kristallspiegel  <p>Stellmaße siehe Seite 19 / 20</p> <p>Innenausstattung: 2 E-Böden 105 cm x 105 cm, 2 Kleiderstangen 71,5 cm</p>  <p>Türen ohne Dämpfung!</p>	108	108	968		992	
	108	108	F99		G03	
	108	108	G01		G04	
	108	108	G02		G05	
	108	108	969		993	
	108	108	989		994	
	108	108	990		995	
	108	108	991		996	

Eckschrank-Maßübersicht

Bedingt durch unterschiedliche Tiefen-Abmessungen ergibt sich folgender Platzbedarf:

Schrank Schenkel L	Schrank Schenkel R	Platzbedarf für ausgebauter Ecke
Dreh/- Falлтürenschrank, Regalelement	SWT-Schrank, 2-4-türig	X = 98,0 cm Y = 94,2 cm
SWT-Schrank, 2-türig	Dreh/- Falлтürenschrank, Regalelement	X = 94,2 cm Y = 101,0 cm
SWT-Schrank, 3-4-türig	Dreh/- Falлтürenschrank, Regalelement	X = 94,2 cm Y = 98,0 cm
SWT-Schrank, 2-türig	SWT-Schrank, 2-4-türig	X = 99,2 cm Y = 102,2 cm
SWT-Schrank, 3-4-türig	SWT-Schrank, 2-4-türig	X = 99,2 cm Y = 99,2 cm



Eckschrank vollausbaut

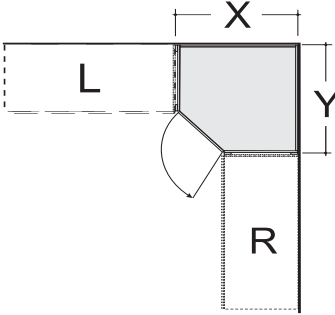





Schrank Schenkel L	Schrank Schenkel R	Platzbedarf für begehbare Ecke
Dreh/- Falлтürenschrank, Regalelement	SWT-Schrank, 2-4-türig	X = 134,4 cm Y = 126,9 cm
SWT-Schrank, 2-türig	Dreh/- Falлтürenschrank, Regalelement	X = 130,6 cm Y = 134,2 cm
SWT-Schrank, 3-4-türig	Dreh/- Falлтürenschrank, Regalelement	X = 130,6 cm Y = 131,2 cm
SWT-Schrank, 2-türig	SWT-Schrank, 2-4-türig	X = 135,6 cm Y = 135,4 cm
SWT-Schrank, 3-4-türig	SWT-Schrank, 2-4-türig	X = 135,6 cm Y = 132,4 cm



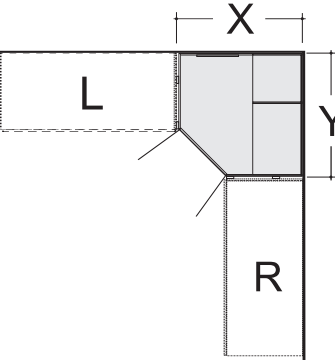

Begehbare Eckschrank mit Drehtüren







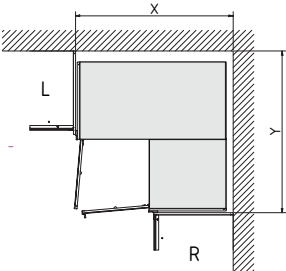
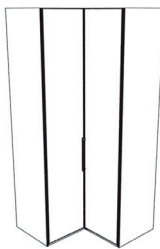



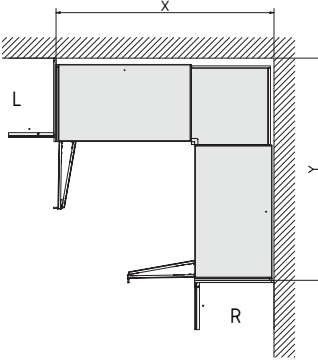
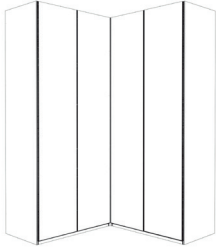

Eckschrank-Maßübersicht

Bedingt durch unterschiedliche Tiefen-Abmessungen ergibt sich folgender Platzbedarf:







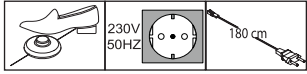

Schrank Schenkel L	Schrank Schenkel R	Platzbedarf für Eckschrank über 90 Grad mit Drehtüren	
Dreh/- Falttürenschrack, Regalelement	SWT-Schrank, 2-4-türig	X = 114,2 cm Y = 107,9 cm	
SWT-Schrank, 2-türig	Dreh/- Falttürenschrack, Regalelement	X = 107,9 cm Y = 117,2 cm	
SWT-Schrank, 3-4-türig	Dreh/- Falttürenschrack, Regalelement	X = 107,9 cm Y = 114,2 cm	
SWT-Schrank, 2-türig	SWT-Schrank, 2-4-türig	X = 114,2 cm Y = 117,2 cm	
SWT-Schrank, 3-4-türig	SWT-Schrank, 2-4-türig	X = 114,2 cm Y = 114,2 cm	
		 Eckschrank über 90 Grad mit Drehtüren	

Schrank Schenkel L	Schrank Schenkel R	Platzbedarf für Eckschrank über 90 Grad mit Falttüren	
Dreh/- Falttürenschrack, Regalelement	SWT-Schrank, 2-4-türig	X = 158,0 cm Y = 156,5 cm	
SWT-Schrank, 2-türig	Dreh/- Falttürenschrack, Regalelement	X = 156,5 cm Y = 161,0 cm	
SWT-Schrank, 3-4-türig	Dreh/- Falttürenschrack, Regalelement	X = 156,5 cm Y = 158,0 cm	
SWT-Schrank, 2-türig	SWT-Schrank, 2-4-türig	X = 158,0 cm Y = 161,0 cm	
SWT-Schrank, 3-4-türig	SWT-Schrank, 2-4-türig	X = 158,0 cm Y = 158,0 cm	
		 Eckschrank über 90 Grad mit Falttüren	

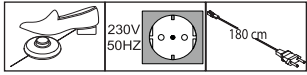

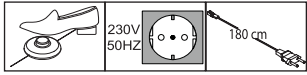
Schrank-Zubehör

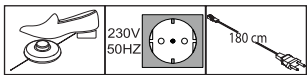
Beschreibung	Maße in cm			Art.-Nr.	EURO
	B	H	T		
 <p>Kollisionsdämpfer</p> <p>- für 2-türige Schränke 1 Stück Optimale Funktion nur in Verbindung mit Außentürdämpfung</p> <p> - für 3-4-türige Schränke 2 Stück Optimale Funktion nur in Verbindung mit Außen- und Mitteltürdämpfung!</p> <p></p>	28	4	2	369	
 <p>Selbsteinzug mit Dämpfung für Mitteltüren</p> <p>- für 3-türige Schränke* Stück 363</p> <p>- für 4-türige Schränke Stück 364</p> <p> * Bitte Deckenhöhe beachten! Montage kann nur von der Schrank-Oberseite erfolgen!</p>	24	2	11		
 <p>2-er Set Selbsteinzug mit Dämpfung für Außentüren, Set für 2-,3-, und 4-türige Schränke</p> <p>Paar</p>	24	2	11	365	

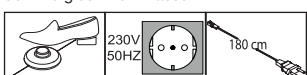
Schrank-Zubehör

Beschreibung	Maße in cm			Art.-Nr.	EURO
	B	H	T		
 <p>LED-Line-Vorbauleuchte, flach in silber</p> <p>Dieses Produkt enthält Lichtquellen der Energieeffizienzklasse E</p>  <p>1 Stück 2 Stück 3 Stück</p> <p> Nur in Verbindung mit Passepartout-Rahmen und Kranzleisten!</p>					
	60	1,5	4,5	980	
	60	1,5	4,5	981	
	60	1,5	4,5	982	
 <p>LED-Line-Aufbauleuchte in silber</p> <p>Dieses Produkt enthält Lichtquellen der Energieeffizienzklasse E</p>  <p>1 Stück 2 Stück 3 Stück</p>					
	60	6	19	983	
	60	6	19	984	
	60	6	19	985	
 <p>LED-Line-Vorbauleuchte, flach in schwarz</p> <p>Dieses Produkt enthält Lichtquellen der Energieeffizienzklasse E</p>  <p>1 Stück 2 Stück 3 Stück</p> <p> Nur in Verbindung mit Passepartout-Rahmen und Kranzleisten!</p>					
	60	1,5	4,5	880	
	60	1,5	4,5	881	
	60	1,5	4,5	882	
 <p>LED-Line-Aufbauleuchte in schwarz</p> <p>Dieses Produkt enthält Lichtquellen der Energieeffizienzklasse E</p>  <p>1 Stück 2 Stück 3 Stück</p>					
	60	6	19	883	
	60	6	19	884	
	60	6	19	885	
 <p>LED-Aufbauleuchte in chrom</p> <p>Dieses Produkt enthält Lichtquellen der Energieeffizienzklasse F</p>  <p>1 Stück 2 Stück 3 Stück</p>					
	5,5	3	22,5	970	
	5,5	3	22,5	971	
	5,5	3	22,5	972	

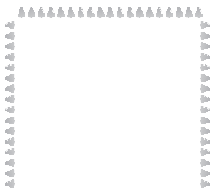
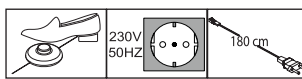
Passepartout-Rahmen für Schwebetürenschränke mit oder ohne Beleuchtung

Beschreibung	Maße in cm		Höhe 221 cm		Höhe 240 cm		
	B	T	Art.-Nr.	EURO	Art.-Nr.	EURO	
 <p>Passepartout-Rahmen, Breite je Seitenstollen 3,2 cm, ohne Beleuchtung</p> <ul style="list-style-type: none"> - für Schrankbreite 150 cm - für Schrankbreite 200 cm - für Schrankbreite 225 cm - für Schrankbreite 250 cm - für Schrankbreite 280 cm - für Schrankbreite 300 cm ⚠ - nur für 3-türige Schränke - für Schrankbreite 300 cm ⚠ - nur für 4-türige Schränke - für Schrankbreite 330 cm - für Schrankbreite 400 cm 	160	23	700		709		
	210	23	701		710		
	235	23	702		711		
	260	23	703		712		
	290	23	704		713		
	310	23	705		714		
	310	23	706		715		
	340	23	707		716		
	410	23	708		717		
	 <p>Aufpreis für umlaufende LED-Beleuchtung (optional):</p> <ul style="list-style-type: none"> - für Schrankbreite 150 cm - für Schrankbreite 200 cm - für Schrankbreite 225 cm - für Schrankbreite 250 cm - für Schrankbreite 280 cm - für Schrankbreite 300 cm ⚠ - nur für 3-türige Schränke - für Schrankbreite 300 cm ⚠ - nur für 4-türige Schränke - für Schrankbreite 330 cm - für Schrankbreite 400 cm 	160	23	737		746	
		210	23	738		747	
		235	23	739		748	
		260	23	740		749	
		290	23	741		750	
310		23	742		751		
310		23	743		752		
340		23	744		753		
410		23	745		754		
<p>Dieses Produkt enthält Lichtquellen der Energieeffizienzklasse F</p> 							
 <p>Nicht nachträglich einbaubar!</p>							



Bitte beachten:

Bei Verwendung eines Passepartout-Rahmens verbreitert sich der Schrank auf die ausgewiesenen Maße.

Passepartout-Rahmen für Schwebetürenschränke mit oder ohne Beleuchtung

Beschreibung	Maße in cm		Höhe 221 cm		Höhe 240 cm	
	B	T	Art.-Nr.	EURO	Art.-Nr.	EURO
 <p>Passepartout-Rahmen, Breite je Seitenstollen: 3,2cm, mit Beleuchtung</p> <p>2 Leuchten - für Schrankbreite 150 cm 4 Leuchten - für Schrankbreite 200 cm 6 Leuchten - für Schrankbreite 225 cm 6 Leuchten - für Schrankbreite 250 cm 6 Leuchten - für Schrankbreite 280 cm</p> <p>6 Leuchten - für Schrankbreite 300 cm ⚠ - nur für 3-türige Schränke</p> <p>8 Leuchten - für Schrankbreite 300 cm ⚠ - nur für 4-türige Schränke</p> <p>8 Leuchten - für Schrankbreite 330 cm 8 Leuchten - für Schrankbreite 400 cm</p>						
	160	23	718		727	
	210	23	719		728	
	235	23	720		729	
	260	23	721		730	
	290	23	722		731	
	310	23	723		732	
	310	23	724		733	
	340	23	725		734	
	410	23	726		736	

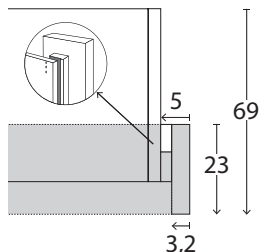
Draufsicht Schrank inkl. PPT-Rahmen



Maße in cm

Dieses Produkt enthält Lichtquellen
der Energieeffizienzklasse F

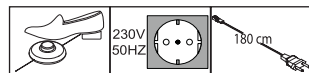





Bitte beachten:

Bei Verwendung eines Passepartout-Rahmens verbreitert sich der Schrank auf die ausgewiesenen Maße.

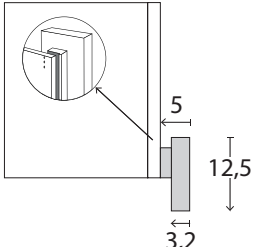

Monaco 3000.

V.i.P.
 by Wiemann

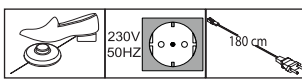
Zusatzelemente für Schwebetürenschränke

Beschreibung	Maße in cm		Höhe 217 cm		Höhe 236 cm	
	B	T	Art.-Nr.	EURO	Art.-Nr.	EURO
 <p>Seitenstollen im Korpus-Farbtou, paarweise</p> <p>Draufsicht Schrank inkl. Seitenstollen</p>  <p>Maße in cm</p> <p> Auch für Monaco 1000 + 2000 verwendbar!</p>	5	12,5	098		099	
 <p>Stollenbeleuchtung</p> <p> Nicht nachträglich einbaubar!</p> <p>Für Seitenstollen und Passepartout-Rahmen ohne umlaufende Beleuchtung verwendbar!</p> <p>Dieses Produkt enthält Lichtquellen der Energieeffizienzklasse F</p> 	1,5	1	100		101	

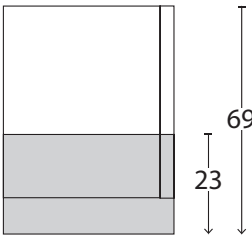
Kranzleisten für Schwebetürenschränke mit oder ohne Beleuchtung

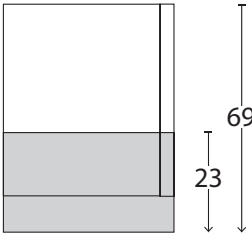



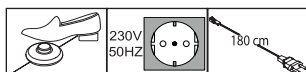



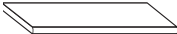
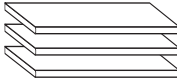

Beschreibung	Maße in cm			Art.-Nr.	EURO
	B	H	T		
 <p>Kranzleiste, ohne Beleuchtung</p> <ul style="list-style-type: none"> - für Schrankbreite 150 cm - für Schrankbreite 200 cm - für Schrankbreite 225 cm - für Schrankbreite 250 cm - für Schrankbreite 280 cm 	150	5	23	900	
	200	5	23	901	
	225	5	23	902	
	250	5	23	903	
	280	5	23	904	
<p>Draufsicht Schrank inkl. Kranzleiste</p>  <p>Maße in cm</p>					
	300	5	23	905	
<p>⚠ - nur für 3-türige Schränke</p> <ul style="list-style-type: none"> - für Schrankbreite 300 cm 	300	5	23	906	
<p>⚠ - nur für 4-türige Schränke</p> <ul style="list-style-type: none"> - für Schrankbreite 330 cm - für Schrankbreite 400 cm 	330	5	23	907	
	400	5	23	908	
 <p>Kranzleiste, mit Beleuchtung</p> <ul style="list-style-type: none"> 2 Leuchten - für Schrankbreite 150 cm 4 Leuchten - für Schrankbreite 200 cm 6 Leuchten - für Schrankbreite 225 cm 6 Leuchten - für Schrankbreite 250 cm 6 Leuchten - für Schrankbreite 280 cm 	150	5	23	909	
	200	5	23	910	
	225	5	23	911	
	250	5	23	912	
	280	5	23	913	
<p>Draufsicht Schrank inkl. Kranzleiste</p>  <p>Maße in cm</p>					
	300	5	23	914	
<p>⚠ - nur für 3-türige Schränke</p> <ul style="list-style-type: none"> 6 Leuchten - für Schrankbreite 300 cm 	300	5	23	915	
<p>⚠ - nur für 4-türige Schränke</p> <ul style="list-style-type: none"> 8 Leuchten - für Schrankbreite 300 cm 	300	5	23	915	
	330	5	23	916	
	400	5	23	917	

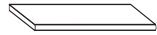
Dieses Produkt enthält Lichtquellen
der Energieeffizienzklasse F



Schrank-Zubehör

Innenausführung: Streifendekor silber-grau





	Beschreibung	Maße in cm			Art.-Nr.	EURO
		B	H	T		
	1 Einlegeboden - für Fachbreite 72,2 cm 1 Stück - für Fachbreite 80,1 cm 1 Stück - für Fachbreite 96,4 cm 1 Stück	72,2 80,1 96,4	2,2 2,2 2,2	51,5 51,5 51,5	036 032 030	
	3 Einlegeböden - für Fachbreite 72,2 cm 3 Stück - für Fachbreite 80,1 cm 3 Stück - für Fachbreite 96,4 cm 3 Stück	72,2 80,1 96,4	2,2 2,2 2,2	51,5 51,5 51,5	038 033 031	
	1 Einlegeboden für vollausgebauten Eckschrank Nicht in Verbindung mit LED-Lichtblende verwendbar!	88	2,2	88	061	
	1 Einlegeboden für begehbaren Eckschrank	72,2	2,2	51,5	046	
	1 Einlegeboden für 90 Grad Eckschrank mit 2 Drehtüren Nicht in Verbindung mit LED-Lichtblende verwendbar!	104,4	2,2	104,4	077	
	1 Einlegeboden für 90 Grad Panorama- Eckschrank mit Falttören	152,4	2,2	152,4	078	
	Kleiderstange - für Fachbreite 72,2 cm - für Fachbreite 80,1 cm - für Fachbreite 96,4 cm	72,2 80,1 96,4	3 3 3	2 2 2	052 051 050	
	1 Kleiderstange für vollausgebauten Eckschrank  Nur zur Montage unter einem E-Boden!	95,8	3	2	082	
	1 Kleiderstange für 90 Grad Eckschrank mit 2 Drehtüren  Nur zur Montage unter einem E-Boden!	71,6	3	2	083	
	1 Kleiderstange für Panorama-Eckschrank über 90 Grad mit Falttören	153	3	2	084	

Monaco 3000.

V.i.P.
by Wiemann

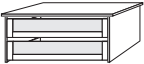
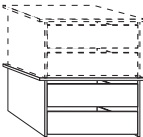

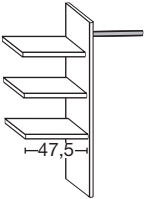

Schrank-Zubehör

Innenausführung: Streifendekor silber-grau

	Beschreibung	Maße in cm			Art.-Nr.	EURO
		B	H	T		
	<p>Schubkasten-Einsatz mit 2 Auszügen mit Kugelauszug und GLASfront für Drehtüren- und Schwebetürenschränke</p> <p>- für Fachbreite 72,2 cm - für Fachbreite 80,1 cm - für Fachbreite 96,4 cm</p>	72,2 80,1 96,4	41 41 41	52 52 52	068 069 070	
	<p>Schubkasten-Einsatz mit 2 Auszügen mit Selbsteinzug und HOLZfront für Drehtüren- und Schwebetürenschränke, stapelbar und auf beliebiger Höhe einbaubar</p> <p>- für Fachbreite 72,2 cm - für Fachbreite 80,1 cm - für Fachbreite 96,4 cm</p>	72,2 80,1 96,4	41 41 41	44 44 44	071 072 073	
 <p>Art.-Nr. 023 Art.-Nr. 024 Art.-Nr. 064</p>	<p>Schubkasten-Einsatz mit 3 Auszügen mit Selbsteinzug und HOLZfront</p> <p>- für Fachbreite 72,2 cm - für Fachbreite 80,1 cm - für Fachbreite 96,4 cm</p>	72,2 80,1 96,4	89 89 89	51,5 51,5 51,5	023 024 064	
	<p>Wäscheboden-Einsatz, bestehend aus</p> <p>3 Einlegeböden, 1 Kleiderstange, 1 Mittelseite</p> <p>- für Fachbreite 72,2 cm - für Fachbreite 80,1 cm - für Fachbreite 96,4 cm</p>	72,2 80,1 96,4	137 137 137	51,5 51,5 51,5	025 026 066	
	<p>Beidseitig (links- oder rechtsseitig) verwendbar!</p> <p>Nur auf Sockelböden stellbar!</p>					

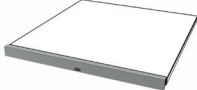
Schrank-Zubehör

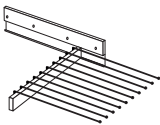
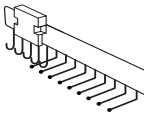
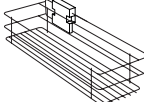
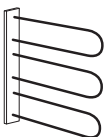
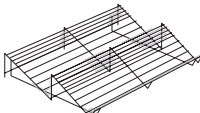
Innenausführung: Streifendekor silber-grau



Beschreibung	Maße in cm			Art.-Nr.	EURO
	B	H	T		
 <p>LED-Lichtblende für Einlegeböden</p> <p>- für Fachbreite 72,2 cm 1 Stück</p> <p>- für Fachbreite 80,1 cm 1 Stück</p> <p>- für Fachbreite 96,4 cm 1 Stück</p> <p>- für Fachbreite 72,2 cm 2 Stück</p> <p>- für Fachbreite 80,1 cm 2 Stück</p> <p>- für Fachbreite 96,4 cm 2 Stück</p> <p>- für Fachbreite 72,2 cm 3 Stück</p> <p>- für Fachbreite 80,1 cm 3 Stück</p> <p>- für Fachbreite 96,4 cm 3 Stück</p> <p> Nicht für begehbbare Eckschränke verwendbar!</p>					
<p>Dieses Produkt enthält eine Lichtquelle der Energieeffizienzklasse F</p>					
 <p>Ausziehbarer Hosenhalter</p>	45	10	50	056	
 <p>Krawatten- und Gürtel-Auszug</p>	7	19	45	059	
 <p>Utensilien-Auszug</p>	16	9	45	076	
 <p>Krawatten- und Gürtelhalter</p>	30	27	9	042	
 <p>Schuhrost für Schrankfach B 96,4 cm</p> <p>- für Fachbreite 96,4 cm</p> <p> Nicht für Falttürenschränke!</p>	96	15	50	094	

Monaco 3000.

V.i.P.
by Wiemann

Schrank-Zubehör

Innenausführung: Streifendekor silber-grau

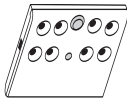
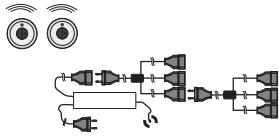
Beschreibung	Maße in cm			Art.-Nr.	EURO
	B	H	T		
 <p>Kleiderlift für Schrankfach-Breite 72,2 - 96,4 cm</p>	100	85	14	081	
 <p>Innenspiegel, klappbar</p> <p>Nur in Verbindung mit Schwebetürenschränken!</p> <p> Nicht in Verbindung mit LED- Lichtblende verwendbar!</p>	36	173	2	080	
 <p>LED-Schrankinnenbeleuchtung mit Bewegungsmelder, inkl. Akku (Ladevorgang über USB)</p> <p>1 Stück</p> <p>2 Stück</p> <p>3 Stück</p> <p>4 Stück</p>	10	2	10	006	
	10	2	10	007	
	10	2	10	008	
	10	2	10	009	
 <p>Fernbedienungs-Set für Beleuchtungen mit 2 Fernbedienungen</p> <p>Bis zu 5 Verbrauchsstellen anschließbar</p>	40	9	13	005	